

JVC | Instruction Book

CD-4 SYSTEM DISC DEMODULATOR **CD4-50**

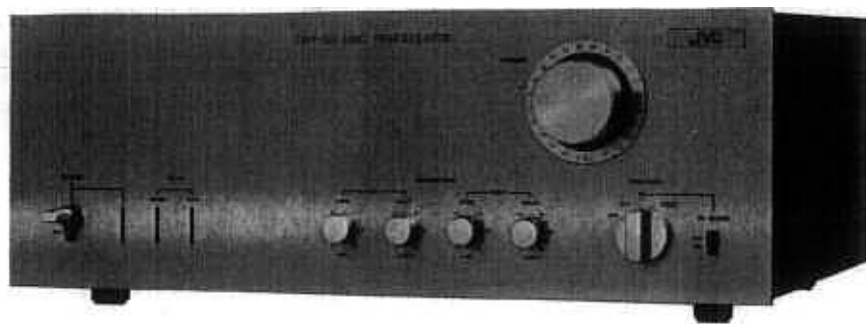

PRECAUTIONS

(1) Separation adjustment

Separation adjustment is performed to accommodate the CD-4 cartridge and stylus being used. When you have done it once, do not move the separation controls and switches until you replace the cartridge or stylus.

(2) Cartridge replacement

Install the cartridge so that the head shell and the cartridge body are parallel to the record surface. (Fig. 4)

(3) Optimum PHONO input level

The allowable input range for this demodulator is from 1mV to 10mV (at 1kHz for rated output). Particularly, the use of a 2-channel cartridge having an output of more than 10mV may cause distorted sound. However, if your pre-amplifier's equalizer can accept that input level, you can use such a cartridge by setting the FUNCTION switch to the DIRECT position.

(4) Playing 2-channel records

Most 2-channel records on the market can be played back properly with the FUNCTION switch at "CD-4" (using either a 2-channel or CD-4 cartridge).

However, some 2-channel records may contain unwanted high frequency signals, which produce abnormal noise when played back at the CD-4 position. Play such records with the FUNCTION switch set to "DIRECT" or "2CH".

(5) Beats

If the turntable speed deviates a great deal from the standard, beats may be heard. If this happens, adjust the turntable rpm correctly.

(6) TV interference

When a CD-4 record is played while the TV receiver is on, interference noise will be heard in CD-4 reproduction. Turn the TV receiver off when you play CD-4 records. If both are to be on, keep an ample space (50cm - 1m) between the TV and the CD-4 record player.

(7) Record storage

In the same way as with 2-channel records, dust and dirt on CD-4 records will degrade the sound quality. Clean the records before and after playing with a preener or cloth cleaner. Do not use a cleaning spray or other cleaners containing solvents. Also avoid washing the records in water (as this may increase noise).

(8) Cleaning the stylus

Dust and dirt adhering to the stylus tip will cause channel separation to deteriorate. Always keep the stylus clean using a stylus cleaner or a brush.

(9) Signal cords

The signal cords from the record player should transmit the super-sonic frequencies to the CD4-50 without any attenuation. Use low-capacitance signal cords for 4-channel use.

(10) Grounding

a) Some AC outlets are provided with a ground terminal. Connect the GND terminal of the CD4-50 to this terminal using a vinyl insulated wire. Be careful not to accidentally insert the wire into the AC outlet socket.

b) If no ground terminal is available at the AC outlet, strip about 50 - 70cm of a 10- to 20-core vinyl insulated wire, wind it onto a water pipe and fix it firmly with electrical tape.

c) Water pipes made of plastic cannot be used for grounding. If metal pipes are not available, bury the stripped end of the wire into the earth to a depth of about 50cm.

Caution! Do not connect the ground wire to gas pipes.

(11) In case of excessive hum

The polarity of the power cords of the record player, CD4-50 and amplifier has an effect on hum. If the humming noise is excessive, re-plug the respective power cords in the opposite direction.

FRONT PANEL CONTROLS

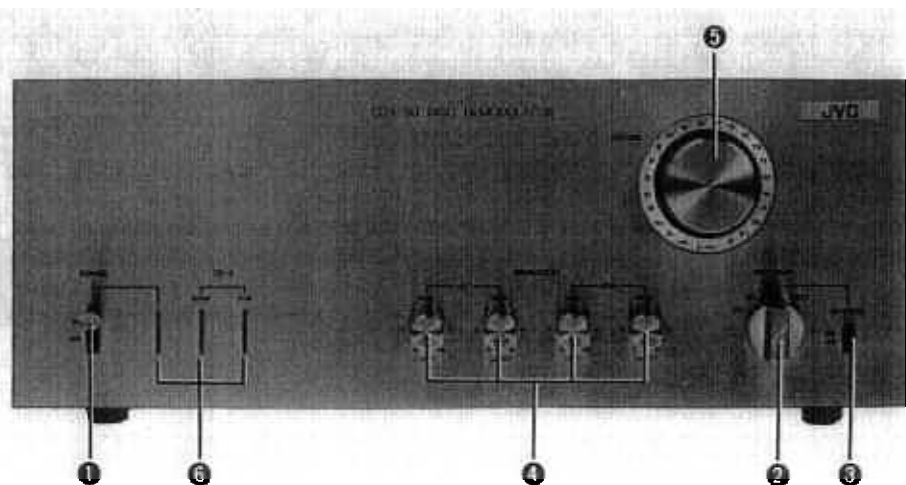

Fig. 1

(1) POWER switch

Flip up to ON to turn the power on.

(2) FUNCTION switch

AUX To play a source connected to the AUX terminals (a 4-channel tape deck, for example).

2CH To play ordinary stereo records. No sound will be heard from the back channel speakers.

CD-4 To play CD-4 records. Stereo records can also be played in this position, with the same channel driving both the front and back channel speakers. (Left front = Left back, Right front = Right back)

DIRECT Set to this position when playing records through the equalizer circuit of a separate amplifier. At this position, the signals applied to the PHONO IN terminals are available at the DIRECT OUT terminals, bypassing the circuitry of the CD4-50.

(3) HI-BLEND switch

Flip up to ON to cancel high frequency noise during CD-4 playing. This switch is only effective when the FUNCTION switch (2) is set to "CD-4".

(4) SEPARATION controls

These controls compensate for the individual output level and phase characteristics of the cartridge being used, thereby providing the best possible channel separation. Read section "SEPARATION ADJUSTMENT" on pages 4 and 5.

(5) VOLUME control

This knob controls the output level of the VARIABLE OUT terminals. When the volume controls for all four channels have been properly adjusted on the connected amplifier(s), this VOLUME control lets you simultaneously lower or raise the total volume.

(6) Indicators

Yellow Lights when the POWER switch is ON.

Green Lights when the FUNCTION switch is set to **(READY)** "CD-4" to indicate that the CD4-50 is ready for CD-4 reproduction. Because of the protector circuit which prevents the click caused by switching on the POWER switch, this lamp lights about 4 seconds after the POWER switch is turned ON.

Red Lights when a CD-4 record starts playing. **(PLAY)** The green lamp will go out during a CD-4 record, but during ordinary stereo records, the green lamp remains lighted.

REAR PANEL CONNECTIONS

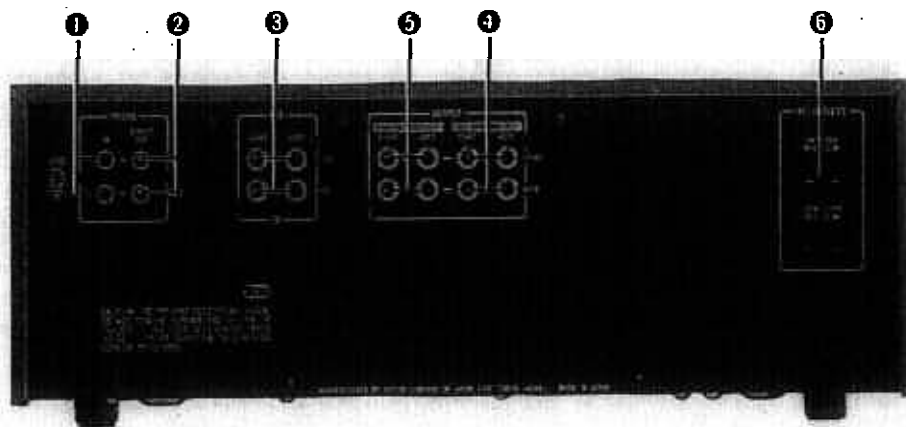

Fig. 2

As well as the basic function of demodulating the CD-4 signals, the CD4-50 also performs some other auxiliary functions.

(1) PHONO IN terminals

Connect the signal cords from a record player.

(2) PHONO DIRECT OUT terminals

The signals applied to the PHONO IN terminals are available at these terminals without being processed when the FUNCTION switch is set to "DIRECT".

For normal use, connect the PHONO DIRECT OUT terminals to the phono input terminals of the amplifier used for the front channels. When the PHONO DIRECT OUT terminals are connected to an amplifier other than those used for the front or back channels, the ground terminal of that amplifier must be connected to the GND terminal of the CD4-50.

(3) AUX terminals

Connect to a 4-channel tape deck or an equivalent equipment. If the tape deck's LINE input is connected to the FIXED OUTPUT terminals of the CD4-50, do not connect the deck's LINE output to the AUX terminals of the CD4-50 (this may cause feedback at some switch positions), but to the AUX IN or tape playback terminals of the connected amplifier(s).

(4) VARIABLE OUTPUT terminals

Connect to the AUX IN terminals of the amplifiers used for front and back channels. With this connection, the VOLUME control of the CD4-50 can be used as a master volume control.

(5) FIXED OUTPUT terminals

The output from these terminals is not controlled by the VOLUME control. Employ as a reference output when using a 4-channel amplifier, to record onto a 4-channel tape deck, for level monitoring, etc.

(6) AC OUTLET

UNSWITCHED — an auxiliary power outlet which provides power regardless of the POWER switch position.

SWITCHED — an auxiliary power outlet which provides power only when the POWER switch is ON.

Do not connect a component having a power consumption of more than 100 watts.

STANDARD CONNECTION DIAGRAM

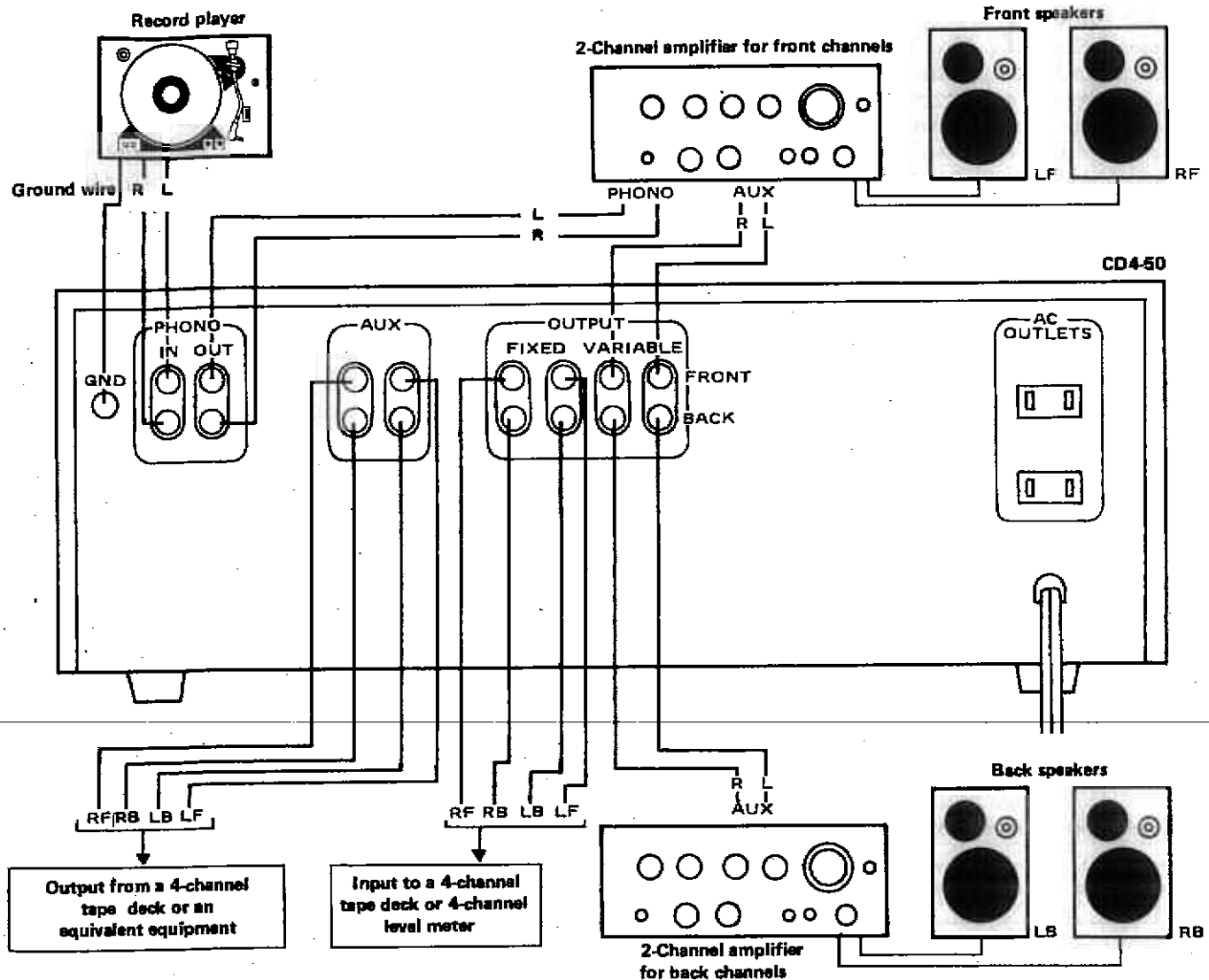

Fig. 3

SEPARATION ADJUSTMENT

Once this adjustment has been made to accommodate the cartridge and stylus being used, no adjustment is needed until you replace the cartridge or stylus.

- (1) Install the cartridge and adjust the tracking force. Then check for overhang, horizontal positioning and vertical positioning.

It is not necessary to use a gauge for these adjustments, but no error should be noticeable to the eye.

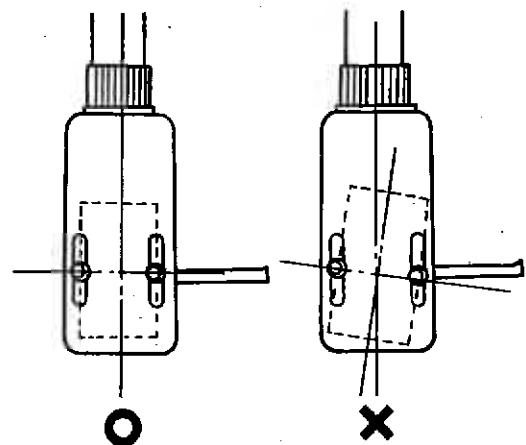
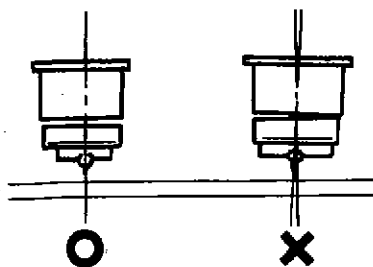

Fig. 4

(2) Use the adjustment record provided for separation adjustment. Play the section of the record which contains a lower frequency signal (600Hz) and turn the LEFT and RIGHT LEVEL controls (shown in Fig. 5) to minimize the sound volume from the back channels. To make this adjustment easier, adjust the amplifier's volume or balance controls beforehand, so that only the corresponding back channel can be heard. The LEVEL control scale values indicate the output level of a cartridge when a record cut with a horizontal amplitude velocity of 5cm/sec (JIS standard) is being played. Use these values as a rough reference if you know the specifications of your cartridge. For instance, JVC's X-1 CD-4 cartridge has a rated output voltage of 2.7mV/

5cm/sec. When this cartridge is used, the point at which the corresponding back channel volume reaches its minimum will be slightly to the left of "2.5" position on the LEVEL control. However, some cartridge manufacturers use different standards to express the cartridge output voltage and it is also probable that the indicated data is different from the actual value. The scale values should, therefore, be considered as just a rough reference. After completing the separation adjustment, play the section of the test record containing a higher frequency signal (4kHz) and adjust the LEFT and RIGHT DELAY controls in the same way as above to minimize the back channel sound volume. (Fig. 5)

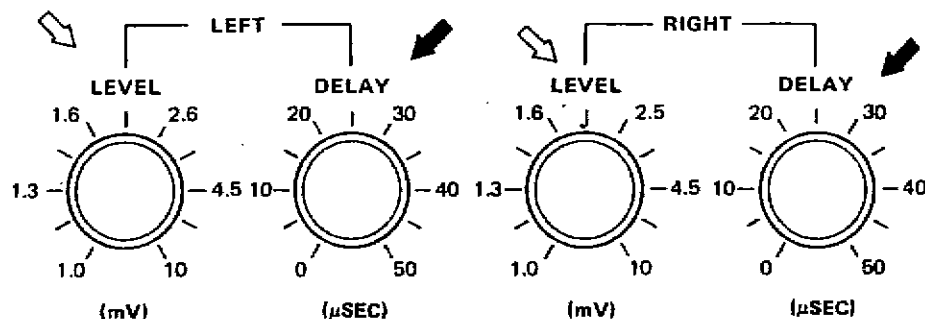

Fig. 5

LIST OF PRIZES AWARDED TO THE CD-4 SYSTEM

1971 **Billboard International Invention Award (USA)**
Officially called the "Trend Setter Award", this prize is awarded yearly by **Billboard**, an American entertainment magazine publisher, to an individual or organization who has made an outstanding contribution to record production or technology.

1972 **Machinery Promoting Association Award (Japan)**
To promote domestic technology, a prize is awarded by the Japan Machinery Promoting Association to organizations which contribute to society by utilizing the results of unique scientific and technological developments for practical applications.

1974 **Montreux International Music Festival Award (Switzerland)**
A prize awarded at the International Music Festival held every summer in Montreux, Switzerland; to people who have been actively contributing to the art of music or who have rendered internationally distinguished services to the art of music. This year, together with conductor Karl Böhm and other artists, Mr. Inoue, Manager of the JVC Audio Engineering Research Center was awarded this prize for his contribution to the development, popularization and promotion of the CD-4 system.

1975 **Okochi Production Award (Japan)**
A prize commemorating the great work of the late Dr. Masatoshi Okochi, who was one of the pioneers of Japan's industrial development. Guided by his slogan: "Scientific Industry", he served as manager of the Institute of Physical and Chemical Research, an incorporated association, and also as chairman of the Physical and Chemical Industry Co., Ltd. during the time before and after World War II. The Okochi Production Prize was started in 1953, and is awarded by the Okochi Commemorative Association, an incorporated association, to newly developed techniques which have been evaluated to be internationally significant to the scientific and technological industries concerned.

1975 **Berliner Special Memorial Award (USA)**
Officially called the "Maker of the Microphone Award". The Berliner Association first awarded this prize in 1963 and will continue doing so for a 25-year period, until 1987. This prize commemorates Emil Berliner, the inventor of the disc record, who also invented the microphone in 1876, at the age of 25. The past prize winners include Dr. H.F. Olson, who made a comprehensive compilation of music engineering, and Bell Systems Inc., which is responsible for a noteworthy number of achievements throughout the history of acoustic technology.

1975 **Ohm Award (Japan)**

LIST OF PATENTS HELD BY JVC RELATING TO CD-4 PLAYBACK SYSTEM

SPECIFICATIONS

Country	Patent No.	Country	Patent No.
USA	3,686,471	France	7,042,730
	3,757,254		7,211,944
	3,795,876	Italy	909,587
	3,798,562		957,498
	3,818,355	Belgium	781,712
	3,839,602		790,588
	3,843,850	Australia	456,244
	3,854,098	Sabah	15 of 1975
	3,870,971	Sarawak	804
	3,883,699	Malaysia	58 of 1975
England	1,337,397	Hong Kong	59 of 1975
	1,346,078	Singapore	34 / 1975
	1,356,848	Uganda	25 of 1975
	1,367,002	St. Helena	43
	1,379,774	Gambia	9 / 1975
Canada	943,788	Japan	746,823
	946,294		748,210
	948,725		748,211
	955,857		
	962,604		

(Many other patents pending)
(As of November 1, 1975)

Semi-conductors	6 IC's, 92 transistors, 8 FET's and 51 diodes
Sum signal section	
Input level	1 – 10mV (at 1kHz) Separation adjustable for inputs within this range.
Maximum input	250mV RMS (at 1kHz)
Frequency response	30 – 15,000Hz (± 0.5 dB RIAA dev.)
Distortion	0.03% or less (at 1kHz)
Residual noise	1.2 μ V (converted into input voltage)
Difference signal section	
Demodulation system	PLL (Phase-Locked Loop) system
Input level	1 – 10mV (at 30kHz)
Frequency response	30 – 10,000Hz (+0.5/-1.0dB)
S/N	Better than 55dB (at 1kHz, standard modulation)
ANRS section	
Frequency response	± 0.5 dB (1kHz, -10VU) ± 1.0 dB (0 to -20VU)
Overall performance	
Rated input	2mV (at 1kHz), 2mV (at 30kHz)
Rated output	250mV (from FIXED OUT or VARIABLE OUT at maximum volume)
Input impedance	100k Ω
Output impedance	Less than 1k Ω
Channel separation	More than 45dB (at 1kHz) when adjusted with a 1kHz signal More than 30dB (at 1kHz) when adjusted with 600Hz and 4kHz signals
Delay time	0 – 50 μ sec variable in 5 μ sec steps
AUX section	
Rated input level	250mV
Rated output level	250mV
Power requirements	
Supply voltage	100/120/220/240V AC, 50/60Hz
Power consumption	20 watts
AC outlets	UNSWITCHED up to 100 watts SWITCHED up to 100 watts
Dimensions	162mm(H) x 420mm(W) x 340mm(D) (6-3/8" x 16-1/2" x 13-3/8")
Weight	7.0kg (15.4 lbs.)

JVC
VICTOR COMPANY OF JAPAN, LIMITED

CAUTION !!

CHECK YOUR
LINE VOLTAGE

This equipment has been preset for a line voltage of **220 V**. Before inserting the power plug, please check that this setting corresponds with the line voltage in your area. If it does not, be sure to reset the voltage selector plug before operating this equipment. The voltage selector plug is located either on the set's rear panel or on the chassis inside the enclosure. Simply remove the voltage selector plug and then firmly reinsert it in such a way that the desired voltage marked on the socket appears in the window of the plug. We cannot accept any responsibility for damage caused to this equipment by improper setting of the voltage selector plug.

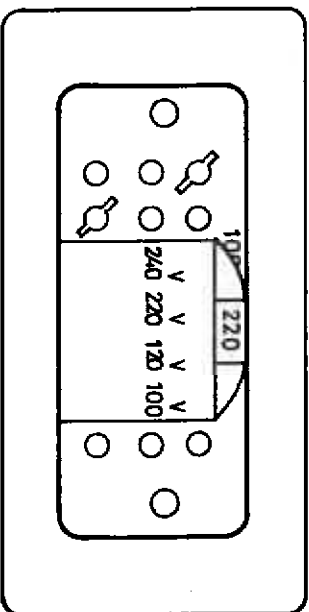

The equipment will be set to the voltage appeared in the window.

Voltage Selector Plug